

---

# Helium Neon Laser System (1 mW – 5 mW) Visible Green 543.5 nm Visible Yellow 594.1 nm Visible Red 632.8 nm

## Operating Manual

This manual covers the following laser systems:

N-LHR-111-xxx
N-LHP-111-xxx
N-LHR-121-xxx
N-LHP-121-xxx
N-LHR-131-xxx
N-LHP-131-xxx
N-LHR-151-xxx
N-LHP-151-xxx
N-LGR-173-xxx
N-LGP-193-xxx
N-LGR-393-xxx
N-LGP-393-xxx
N-LYP-173-xxx
N-LYP-373-xxx

L10462-3A REV: 3.20.1 NPT

# Table of Contents

CONTENTS	PAGE NUMBER
<b>1.0 Introduction</b> .....	1
1.1 Unpacking.....	1
1.2 About This Manual.....	1
1.3 Conventions Used in This Manual .....	2
1.4 Trademark Acknowledgment.....	3
<b>2.0 Safety and Regulatory</b> .....	4
2.1 Eye Safety.....	4
2.2 Electrical Shock .....	4
2.3 Center for Devices and Radiological Health Regulations .....	4
2.4 RoHS Compliance .....	5
<b>3.0 Labels</b> .....	6
3.1 Aperture Label .....	6
3.2 Warning, Model Information and Certification Label .....	6
3.3 Label Locations .....	7
<b>4.0 Mechanical Specifications</b> .....	8
4.1 Laser Head Dimensions .....	8
4.2 Laser Head Suggested Mounting.....	8
4.3 Power Supply Outline Diagrams .....	9
<b>5.0 Operation Instructions</b> .....	10
5.1 Operation .....	10
5.2 Power Supply Remote Connector.....	11
<b>6.0 Trouble Shooting</b> .....	12
<b>7.0 Instructions for Warranty Service</b> .....	13
7.1 Sales Service and Technical Support Center .....	13

# 1.0 Introduction



---

**Use of controls or adjustments or performance of procedures other than those specified herein may result in hazardous radiation exposure.**

---



---

**Wenn andere als die hier angegebenen Kontrollfunktionen oder Einstellungen oder die Ausführung von Abläufen erfolgen, kann zu einer Aussetzung von gefährlicher Strahlung führen.**

---

Congratulations! You have just purchased a high-quality Newport Helium Neon laser. It has been designed to provide you with reliable, dependable service with no maintenance.

Each laser complies with the United States Department of Health and Human Services/ Center for Devices and Radiological Health radiation performance standards (21 CFR 1040.10) for Class IIIa product, as well as Class 3R per IEC laser safety standard.

## 1.1 Unpacking

When unpacking the laser system, look for dents, scratches and other signs of damage to the packaging or components. If damage is evident, immediately file a claim with the shipper and contact your nearest Distributor (see website for contact information). This will help in any resulting insurance claims.

The laser has been packed in a specially designed container. It is suggested that the packing material is saved for future use.

## 1.2 About This Manual

This manual describes the proper operation of the Helium Neon Laser system to avoid inadvertent damage to the system or accidental injury to the operator. Please read the manual completely before attempting to operate the laser system and carefully heed all cautionary notes. If you have any questions or comments about this manual or the laser system itself, please call your local sales or service office.

The manufacturer reserves the right to make changes to this manual and to the equipment described herein without notice. Considerable efforts have been made to ensure that the information in this manual is accurate and complete. However, the manufacturer will not be liable for any technical or editorial errors or omissions made herein or for incidental, special, or consequential damages of any nature resulting from the furnishing of this manual, or operation and performance of equipment in connection with this manual.

## 1.3 Conventions Used in This Manual

Throughout this manual you will find information that is separated from the regular text by lines and labeled by an icon in the margin. Lasers are potentially dangerous devices, and some of this information is vital for your safety. The significance of the notations is explained below.



---

Lasers are electrical devices and improper use can expose the operator or others to potentially lethal voltages. The “Hazard” icon, represented by a triangle with a lightning bolt, identifies precautions needed to avoid *electrical* injury or damage to the equipment.

---



---

The series of laser systems which are covered by this manual are classified as Class IIIa devices as defined by the Center for Devices and Radiological Health of the United States Food and Drug Administration and Class 3R devices as defined by IEC 60825-1. The eyes may be damaged if exposed to the laser beam. The “Caution” icon, represented by a triangle with laser burst, identifies precautions needed to avoid *eye* injury to anyone in the area.

---



---

The “Note” icon, represented by a triangle with an exclamation point, indicates information that is particularly important to the optimum performance of the laser system or information about the procedure or topic under discussion.

---

The following acronyms are used in this manual:

CDRH	Center for Devices and Radiological Health
cw	Continuous Wave
FCC	Federal Communications Commission
IEC	International Electrotechnical Commission
OEM	Original Equipment Manufacturer

The following abbreviations and symbols are used in this manual:

ac	alternating current
dc	direct current
in	inch
mm	millimeter
Vac	Volts ac
Vdc	Volts dc
kVdc	kilovolt dc
W	Watt
mW	milliwatt
A	Amp
mA	milliamp
nm	nanometers
mrاد	milliradians
MHz	Megahertz
<i>g</i>	acceleration

## 1.4 Trademark Acknowledgment



The remainder of this page is intentionally left blank.

## 2.0 Safety and Regulatory

---



Note

All maintenance or service requiring access to the interior of the laser or power supply must be performed by a factory authorized representative. In addition, removal of any product labels will void your warranty.

---

### 2.1 Eye Safety

The HeNe laser systems that are described in this manual are within the CDRH Class IIIa laser category and have been designed to meet or exceed safety regulations. However, sensible precautions must be exercised in use, as with any laser light source. Avoid eye exposure to either direct or reflected beam radiation. Impaired vision or irreparable damage may result from direct exposure. Always wear appropriate protective eyewear when operating the device(s).

The products are equipped with a mechanical shutter on the front, or output, end of the housing. This shutter can be closed when the laser is in operation to prevent inadvertent exposure to the beam. This allows the beam to be interrupted without cooling down the laser from its stable operating condition.



Caution

Never look into the laser beam or into the laser aperture (even when the laser is off), with or without appropriate safety goggles. Permanent eye damage or blindness may result! In addition, keep all parts of the body and reflective materials out of the beam path.

---

### 2.2 Electrical Shock

Dangerous electrical voltages are present within these devices. At no time shall the laser be operated without the proper electrical connections in place.



Hazard

High voltage is present at the laser head connection.

---

### 2.3 Center for Devices and Radiological Health Regulations

All laser products sold in the United States must conform to performance and safety regulations 21 CFR 1040.10 and 1040.11, established by the Department of Health and Human Services/Center for Devices and Radiological Health radiation performance standards (DHHS/CDRH).

The emitted light is at a wavelength of 632.8 nm, 594.1 nm or 543.5 nm based on the product's model number and no X-ray or other harmful radiation is emitted.

For further information and guidance on Federal Performance Standards for Laser Products, contact:

United States Food and Drug Administration  
<http://www.fda.gov/>

A Laser Safety Guide is also available from:

Laser Institute of America  
<https://www.lia.org/>

## 2.4 RoHS Compliance

### ROHS-3 DIRECTIVE 2015/863/EU

The products covered by this manual comply with RoHS 3, Directive (EU) 2015/863, which adds 4 phthalates to previous RoHS 2 Directive 2011/65/EU. Specifically, the products containing the substances listed below are in concentrations below the MCV or are exempt. The products are therefore understood to be in compliance with Directive (EU) 2015/863 of the European Parliament and the Council of 4 June 2015 on the restriction on the use of certain hazardous substances in electrical and electronics equipment (RoHS Directive) in accordance with the definitions set forth.

#### Newport Part Numbers:

N-LHP-xxx      N-LHR-xxx      N-LGP-xxx      N-LGR-xxx      N-LYP-xxx

Substance	Compliance Reason
Lead (Pb)	The subject product does not contain substances in excess of the maximum concentration values tolerated by weight in homogeneous materials as listed in Annex II of the Directive, or per directive 2011/65/EU, Annex III, are exempted from the Restriction in Article 4(1), per 7(c)-I: "Electrical and electronic components containing lead in a glass or ceramic other than dielectric ceramic in capacitors."
Mercury (Hg)	There is no intentional use
Cadmium (Cd)	There is no intentional use
Hexavalent Chromium (Cr+6)	There is no intentional use
Polybrominated Biphenyls (PBB)	There is no intentional use
Polybrominated diphenyl ethers (PBDE)	There is no intentional use
Hexabromocyclododecane (HBCDD)	There is no intentional use
Bis (2-Ethylhexyl) phthalate (DEHP)	There is no intentional use
Dibutyl phthalate (DBP)	There is no intentional use
Benzyl butyl phthalate (BBP)	There is no intentional use
Diisobutyl phthalate (DIBP)	There is no intentional use

China RoHS  
Hazardous Substance Table

氦氛激光器 Helium Neon Laser Systems	有毒有害物质 Hazardous Substance					
	铅 (Pb)	汞 (Hg)	镉 (Cd)	铬6+ (Cr <sup>6+</sup> )	多溴 联苯 (PBB)	多溴二 苯醚 (PBDE)
激光头 Laser Head	o	o	o	o	o	o
激光管 Laser Tube if Sold By Itself	x	o	o	o	o	o
电源供应器 Laser Power Supply	o	o	o	o	o	o
O: 表示该有毒有害物质在该部件所有均质材料中的含量均在SJ/T 11363-2006标准规定的限量要求以下 Expresses that this hazardous substance is below the specified limits as described in SJ/T 11363-2006.						
X: 表示该有毒有害物质至少在该部件的某一均质材料中的含量超出SJ/T 11363-2006标准规定的限量要求 (企业可在此处, 根据实际情况对上表中打" X"的技术原因进行进一步说明) Expresses that this hazardous substance is above the specified limits as described in SJ/T 11363-2006.						
除非另外特别的标注, 此标志为针对所涉及产品的环保使用标志, 某些零部件会有一个不同的环保使用期 (例如, 电池单元模块) 贴在其产品上。 此环保使用期限只适用于产品是在产品手册中所规定的条件下工作。 The Environmentally Friendly Use Period (EFUP) for all enclosed products and their parts are per the symbol shown here, unless otherwise marked. Certain parts may have a different EFUP and are so marked to reflect such. The Environmentally Friendly Use Period is valid only when the product is operated under the conditions defined in the product manual.						



This declaration is based on information obtained from suppliers and/or analytical material testing. The manufacturer makes every reasonable effort to ensure the accuracy of this information as of the date of publication. This declaration of conformity is used under sole responsibility of the manufacturer and is valid unless superseded by a revised certification at a later date.

## 3.0 Labels

The following illustrations show the labels which are attached to the laser. The locations of these labels are indicated on the following drawings. These labels and other safety features are required by the United States Department of Health, Education and Welfare, Center for Devices and Radiological Health, by their Radiation Performance Standards (21 CFR 1040.10).

### 3.1 Aperture Label



### 3.2 Warning, Model Information and Certification Labels

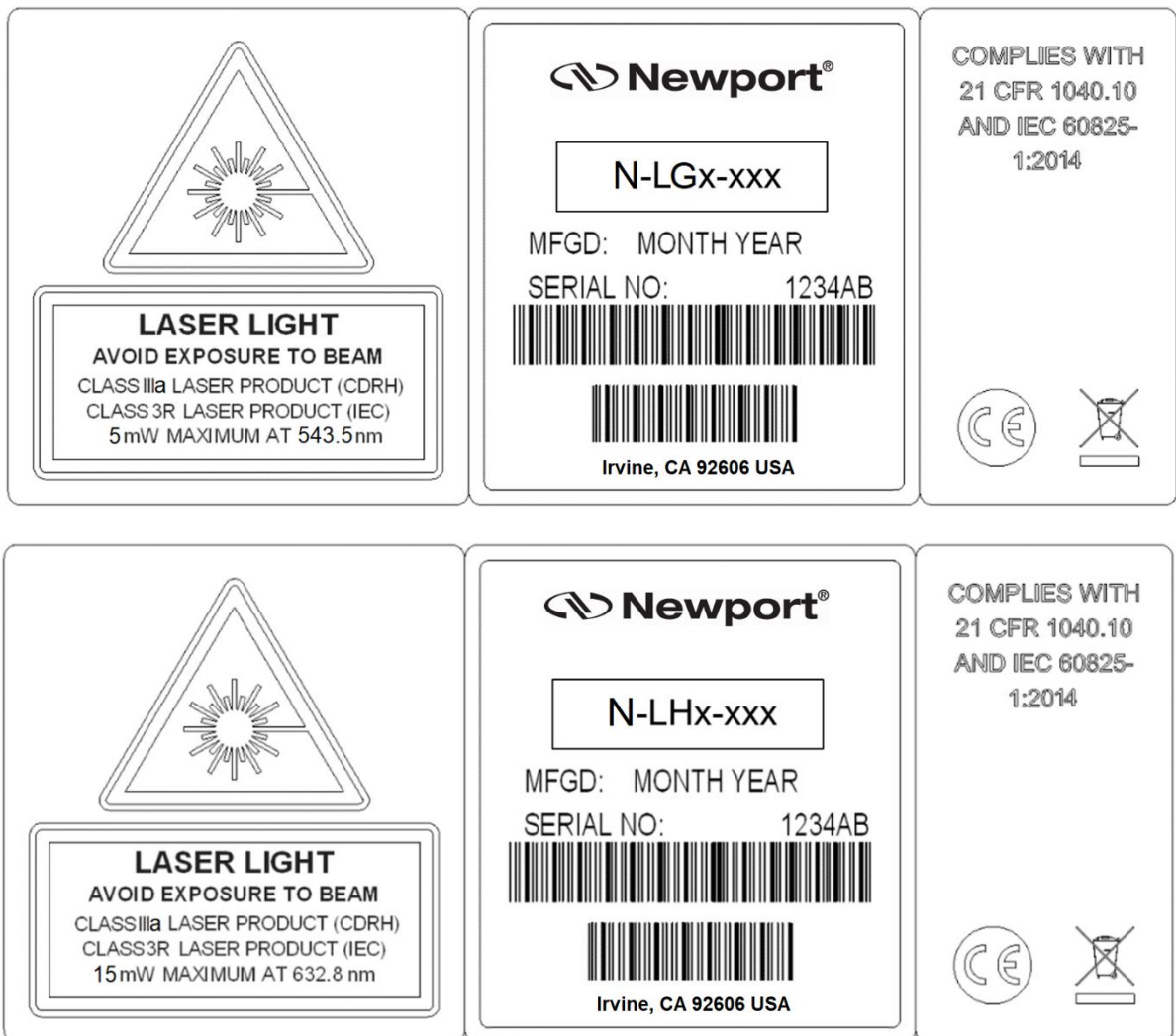



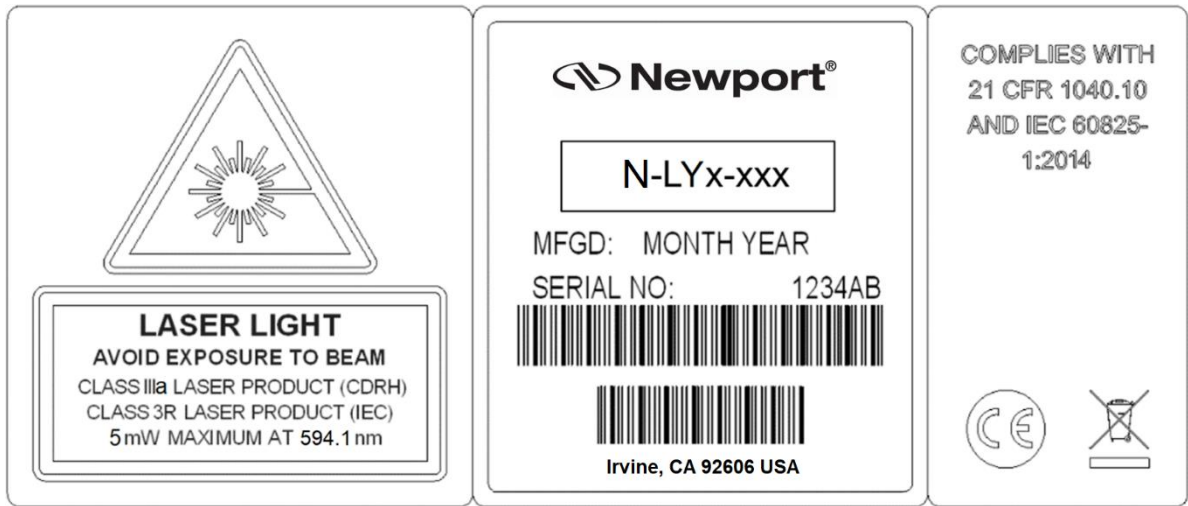

### 3.3 Label Locations

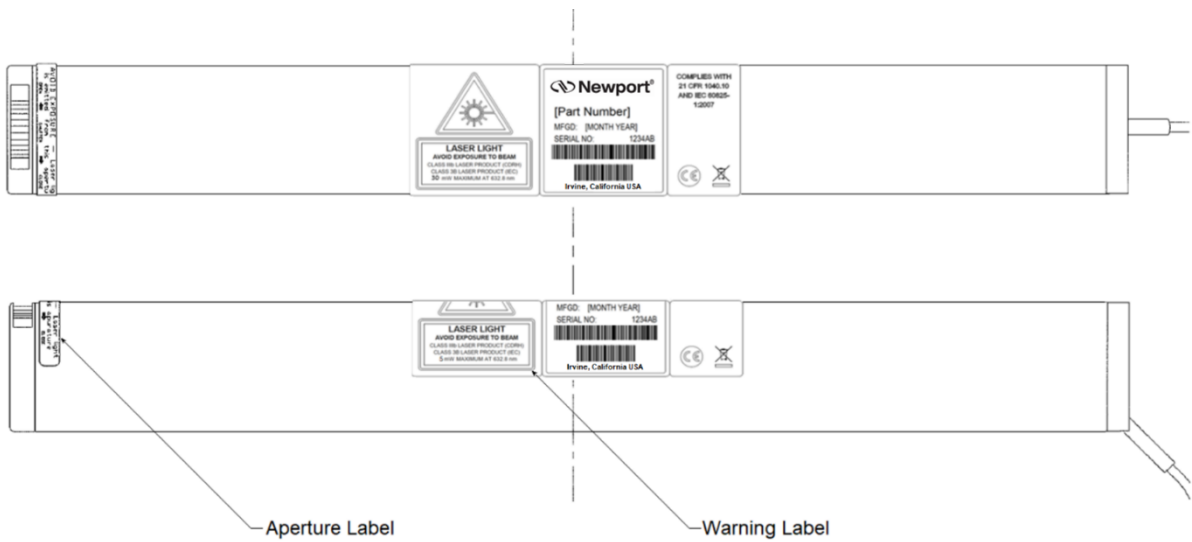

## 4.0 Mechanical Specifications

### 4.1 Laser Head Dimensions

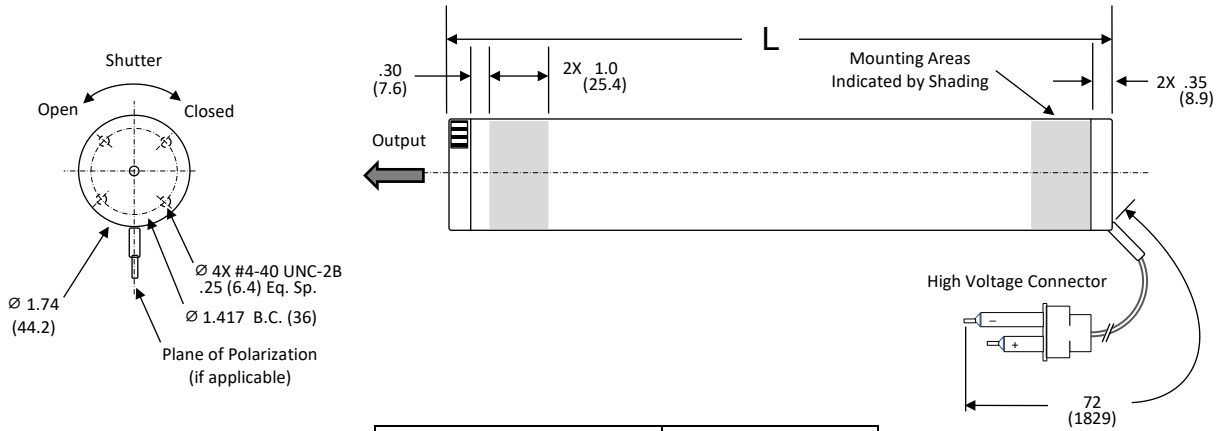

Model Number	Length (L) Inches (mm)
N-LHx-111, 121	10.70 (271.8)
N-LHx-131	9.50 (241.3)
N-LHx-151	15.60 (396.2)
N-LGx-173	17.95 (455.9)
N-LGx-193, 393	20.09 (510.3)
N-LYx-173, 373	17.95 (455.9)

### 4.2 Laser Head Suggested Mounting

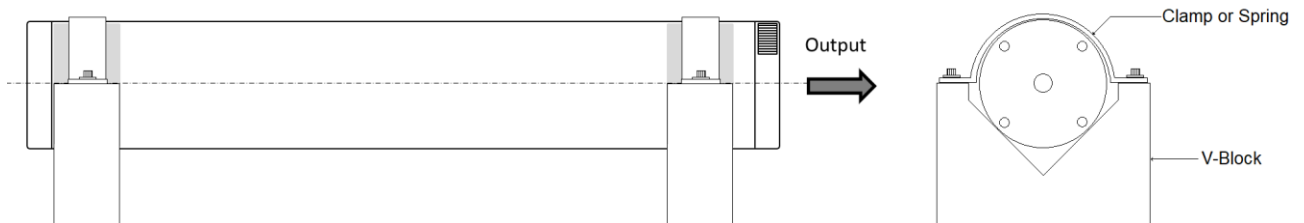

Note



The V-blocks must be aligned straight to one another so that the laser housing is not stressed. The clamps should be loose enough to allow the laser to expand longitudinally in the V-blocks.

### 4.3 Power Supply Outline Diagrams

Laser Heads N-LHx-111, 121, 131, 151, N-LGx-173, 373:

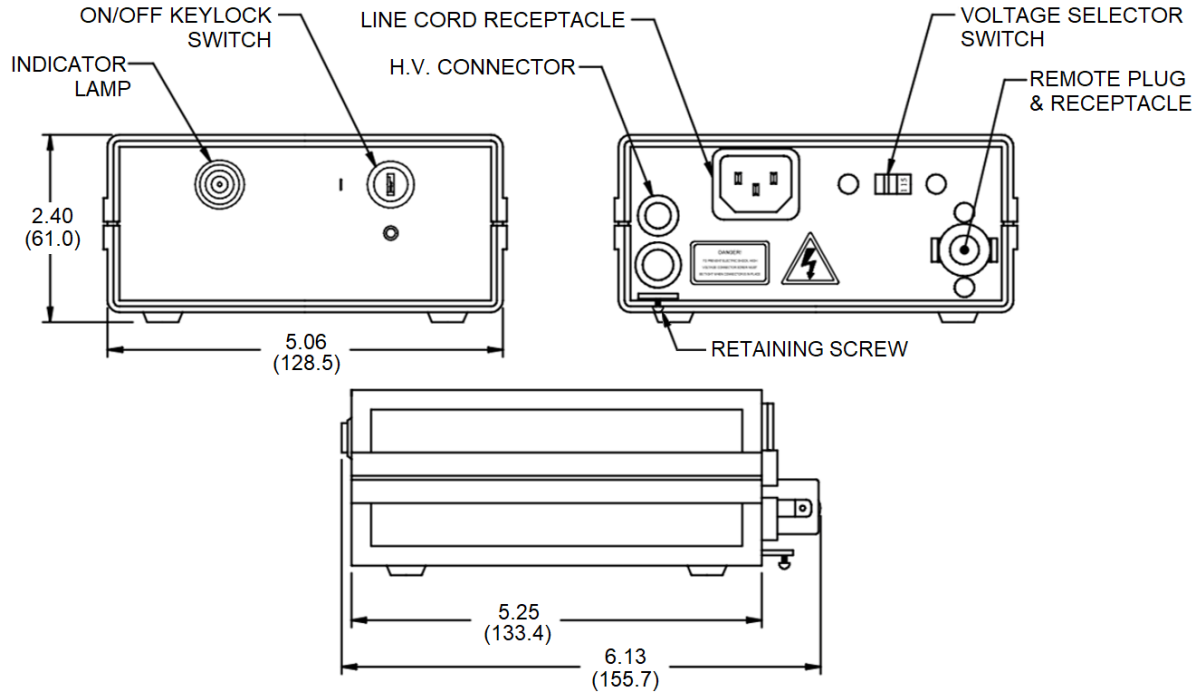

Laser Heads N-LGx-193, 393:

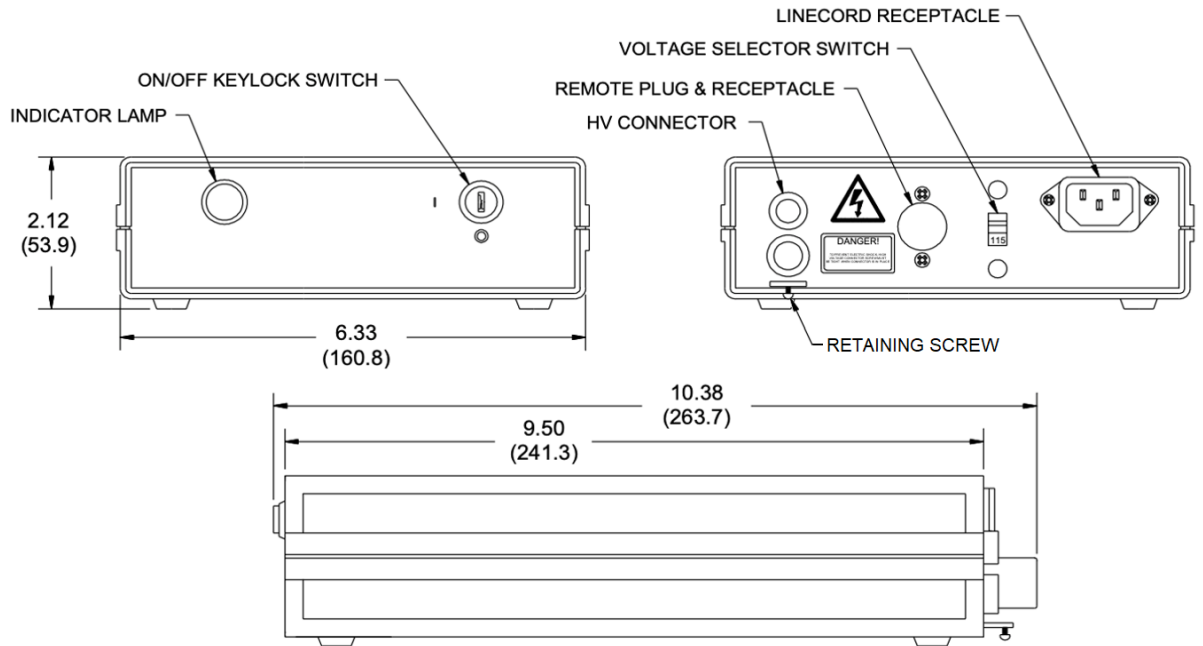

inch (mm)



## 5.0 Operation Instructions

The laser system includes a laboratory style power supply. This power supply is a turnkey device and is wired for switchable 115 VAC or 230 VAC (50 or 60 Hz) operations.

Note



---

Section 2.0, Safety precaution must be referred to prior to operation.

---

### 5.1 Operation

Hazard



---

High voltage is present at the laser head connection. Do not turn *on the power supply WITHOUT A LASER CONNECTED*. If you do, turn off the power supply and wait *AT LEAST FIVE MINUTES* before connecting the laser.

---

1. Make certain the power supply key switch (front panel) is in the “O” (off) position.
2. Check that the voltage setting on the voltage selector switch (rear panel) matches the actual AC input voltage.

Note



---

Failure to set the power supply voltage selector switch to the correct input voltage will damage the power supply and void the warranty.

---

3. Ensure that the power supply interlock plug is firmly in place in the rear of the power supply. This is a black, 2 pin plug.
4. Set up the laser head so that the output end of the laser is directed on a non-reflective surface and ensure that the output endcap shutter is open.
5. Connect the laser head protective earth ground terminal (if equipped) at the back of the laser head to earth ground.
6. Turn the retaining screw underneath the power supply high voltage connector (Section 4.3) full travel counterclockwise.
7. Plug the male high voltage connector from the laser head into the power supply high voltage connector. This connection is a tight fit. To prevent faulty operation, be sure the male connector is fully seated.
8. To prevent the possibility of electric shock, secure the connection by turning the retaining screw underneath the power supply high voltage connector full travel clockwise.
9. Insert the line cord into the power supply receptacle (rear panel).
10. Plug the other end of the line cord into an appropriate receptacle.
11. Turn the power supply on by switching the power switch to the “I” (on) position.
12. The indicator light will turn on immediately. There will be a 3 to 8 second safety delay before the laser turns on. On lasers equipped with a safety shutter, laser emission will not be visible until the shutter is opened.

## 5.2 Power Supply Remote Connector

Hazard



---

Mains voltage (115 VAC or 230 VAC) is present on remote connector terminals when power supply key switch is in the “I” (on) position. Power Supply must be switched to the “O” (off) position and disconnected from mains power before removing the remote connector plug from the socket.

---

The remote connector is provided as a safety feature to allow remote actuation of the laser power supply. If remote actuation is desired, ensure that the cable and remote switch are rated for the specified power supply input voltage and current. The remote switch will actuate the power supply only when the main power switch is switched on (“I”). As supplied, the polarized remote connector plug is wired with an internal jumper. If the connector is to be used with a remote external switch, modify the plug as follows:

1. Switch off power and disconnect power supply from main power.
2. Remove remote connector plug from socket on power supply rear panel by pulling straight out.
3. Press out silver-colored locking pin. Do not discard pin.
4. Remove plug shell.
5. Remove vinyl cap covering plug terminals.
6. Remove shorting wire from plug terminals.
7. Slide the plug shell onto remote connector cable.
8. Solder cable leads to plug terminals.
9. Slide the plug shell back on to plug.
10. Install locking pin removed in step 3.
11. Insert connector into socket on power supply rear panel.

Note



---

If the laser system is not operated in accordance with these instructions, the function of essential safety features will be impaired. The laser system has no user serviceable parts within and requires no user maintenance.

---

## 6.0 Troubleshooting

Helium Neon lasers are very dependable in operation and should not cause any operational problems. If the laser fails to provide an output beam within 10 seconds of being turned on, refer to section 5.1 on page 10. If all conditions are correct and the laser still fails to operate, it should be returned for service.

Note



---

The laser power supply has no user serviceable parts within and requires no user maintenance.

---

## 7.0 Instructions for Warranty Service

Our Helium Neon lasers are guaranteed for a period of 12 months after the date of purchase. There is no limit to the operational hours during this time. The only exception to this warranty is obvious misuse, damage or breakage for the laser tube or housing. Should the power level of this laser fall below the specified minimum power level within the time limit, it will be repaired or replaced free of charge. Neither the laser head nor power supply are user serviceable by the user.

Before returning your laser for warranty or normal service, contact a customer service representative for a return authorization number as specified in Section 7.1.

We will provide you with a convenient shipping address at that time. In the case of non-warranty service, a quote will be provided for the cost of repair (after receipt and inspection) for your approval before any work is done.

When returning the laser for service, please repack the laser carefully in the original shipping container. This container has been carefully designed to protect your laser during transit, and we strongly urge you to use it. If the original container is no longer available, please advise us of this when you contact us for your return authorization number. We will be pleased to ship a new, empty container (for a nominal charge) for use in returning the laser to us.

### 7.1 Sales, Service and Technical Support Center

#### **UNITED STATES**

Newport Corporation  
1791 Deere Avenue  
Irvine, California, 92606 USA  
Attention: Customer Service

Phone (949) 863-3144

[www.newport.com/contact-us](http://www.newport.com/contact-us)

Please visit: <https://www.newport.com/contact/contactlocations>  
for International Distributors and Representatives